

**M12 male 0° / M12 female 0° F&B Pro**

TPE-S 4x0.34 bu UL robot+drag chain 7m

Plug Connectors for Food &amp; Beverage

Further cable lengths on request.

Male straight – female straight

M12 F&amp;B Pro

4-pole

Stainless steel 1.4404 (V4A)

without cable sleeves

IP69K

Plastic housings with good resistance against chemicals and oils.

The resistance to aggressive media should be individually tested for your application. Further details on request.

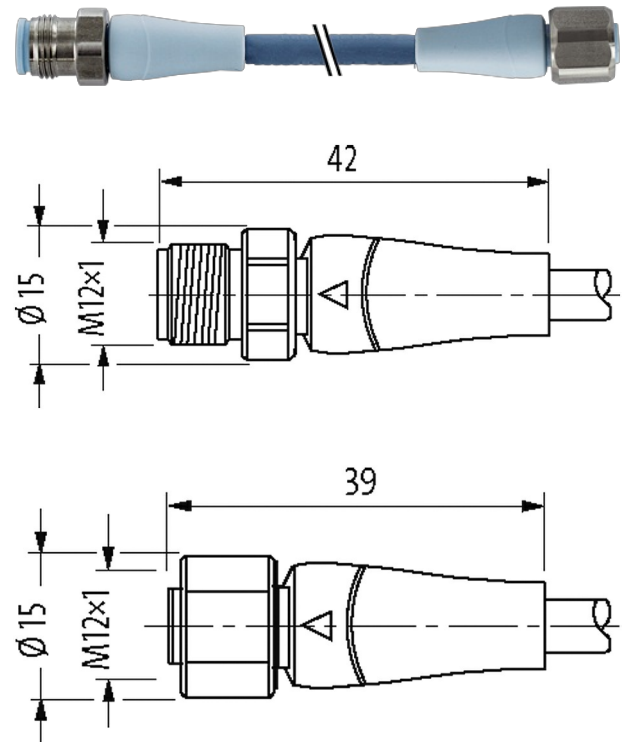
[Link to Product](#)**Illustration**

Product may differ from Image

**Approvals****Form**

Form 40021

**General data**

Standards DIN EN 61076-2-101 (M12), FDA conform

Mounting method inserted, tightened

Material (contact)	Copper alloy
Material (contact surface)	Au
Material (contact carrier)	PP, ice blue
Material (gasket)	EPDM
Pollution Degree	3
Temperature range	-40...+105 °C, depending on cable quality

### Cables

Cable number	321
No./diameter of wires	4 × 0.34 mm <sup>2</sup>
Wire isolation	PP (br, wh, bl, bk)
C-track properties	4 Mio.
Jacket Color	pastel blue
Material (jacket)	TPE-S
Outer Ø	4.7 mm ±5%
Bend radius (moving)	10 × outer Ø
Temperature range (fixed)	-40...+105 °C
Temperature range (mobile)	-25...+105 °C
Cable identification	321
Approval (cable)	UL (AWM-Style 22126/11558), CE conform
Cable weight [g/m]	29,70
Material (wire)	Cu wire, bare
Resistor (core)	max. 58 Ω/km (20 °C)
Single wire Ø (core)	0.1 mm
Construction (core)	42 × 0.1 mm (multi-strand wire class 6)
Diameter (core)	4 × 0.34 mm <sup>2</sup>
AWG	similar to AWG 22
Material (wire isolation)	PP
Material property (wire isolation)	CFC-, halogen-, cadmium-, silicone- and lead-free
Shore hardness (wire isolation)	64 ±3 D
Wire-Ø incl. isolation	1.27m ±5%
Color/numbering of wires	br, bk, bl, wh
Stranding combination	4 wires twisted
Shield	no
Material (jacket)	TPE-S (laser-markable)
Material property (jacket)	CFC-, halogen-, cadmium-, silicone- and lead-free, matt, low-adhesion, machine easy to process, abrasion-resistant, hydrolysis and microbial resistant
Shore hardness (jacket)	47 ±5 D
Outer-Ø (jacket)	4.7 mm ±5%
Color (jacket)	pastel blue
Nominal voltage	300 V AC
Test voltage	3000 V AC
Current load capacity	to DIN VDE 0298-4
Temperature range (fixed)	-40...+105 °C
Temperature range (mobile)	-25...+105 °C
Bend radius (fixed)	5 × outer Ø
Bend radius (moving)	10 × outer Ø
No. of bending cycles (C-track)	max. 4 Mio. (25 °C)
Traversing distance (C-track)	max. 10 m
Travel speed (C-track)	max. 3 m/s

Acceleration (C-track)	max. 10 m/s <sup>2</sup>
Torsion stress	±180°/m
No. of torsion cycles	max. 2 Mio. (25 °C)
Torsion speed	35 cycles/min

#### Technical Data

Operating voltage	max. 250 V AC/DC
Rated surge voltage	2.5 kV
Operating current per contact	max. 4 A
No. of poles	4-pole
Material group	IEC 60664-1, category I
Coding	A-coded
LED display	no
Locking of ports	Screw thread (M12×1 mm) recommended torque 0.6 Nm, self-securing
Compression gland	M12 (SW14)
Protection	IP65, IP68, IP69K inserted and tightened (EN 60529)
Material	PP
Locking material	Stainless steel 1.4404 (V4A)
suitable for corrugated tube (internal Ø)	without

#### Commercial data

country of origin	DE
customs tariff number	85444290
EAN	4048879841672
eClass	27279218
Packaging unit	1

#### Sketch

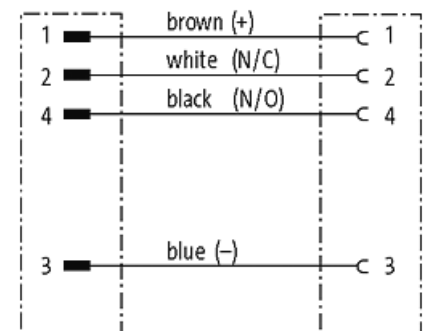

Male

Female

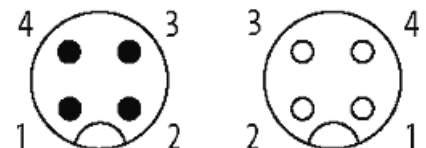

Product may differ from Image